

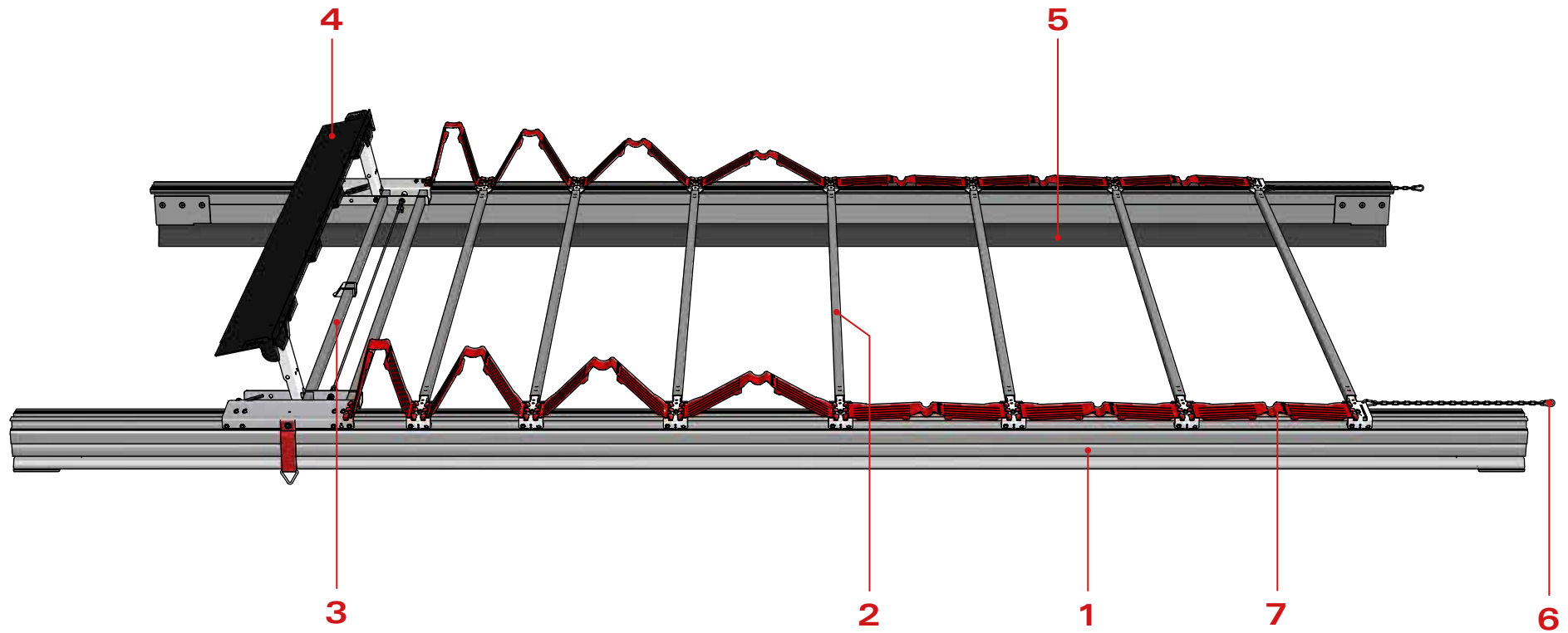

Ω : SOLO PENTA

Versus



1	Solo rails
2	Roof stick
3	Collapsible backside
4	Back beam
5	PVC pelmet

6	Set accessories
7	Folding plate
8*	Carapax plate
9*	Pull bar

* Not visible on the composition drawing above.

1 Solo rails

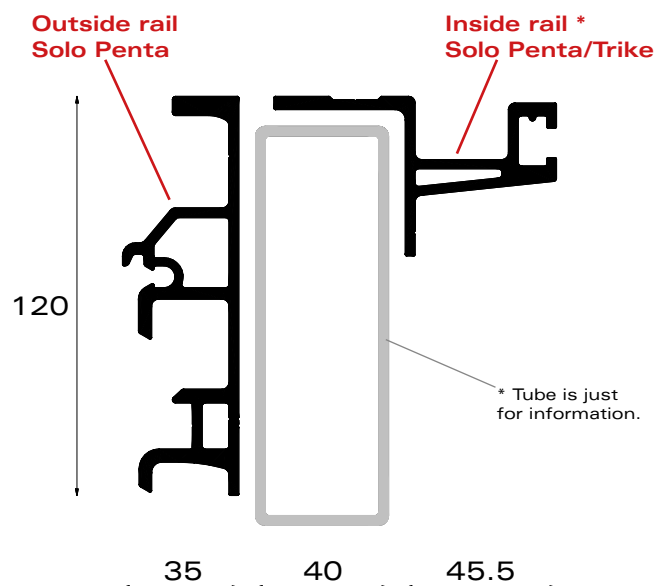

PART NR.

Rail (out) L = 7,8m	162-41780
Rail (out) L = 8,5m	162-41850
Rail (in) L = 7,8m	162-43780
Rail (in) L = 8,5m	162-43850

Outside rail Solo Penta

lx : 130cm⁴
ly : 10cm⁴
± 2,8 kg/m

Inside rail Solo

lx : 9cm⁴
ly : 33cm⁴
± 1,8 kg/m

* Inside rail serves for Solo Penta and Solo Trike

2a Roof stick for sliding roof



PART NR.

SB=2550 - Type SP	224-39001
SB=2550 - Type AS (Al)	224-39021

2b Roof stick for fixed roof with polyester cover



PART NR.



SB=2550 - Type SP	224-39101
SB=2550 - Type AS (Al)	224-39121
Mounting set roof stick fix	144-10049

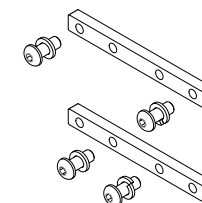

* Roof stick screwed to rail with bolts

* 1 set/roof stick

2c Roof stick for fixed roof with tarpaulin cover



PART NR.



SB=2550 - Type SP	224-39201
SB=2550 - Type AS (Al)	224-39221
Mounting set roof stick fix	144-10049

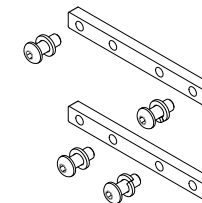

* Roof stick screwed to rail with bolts

* 1 set/roof stick

3a Collapsible backside

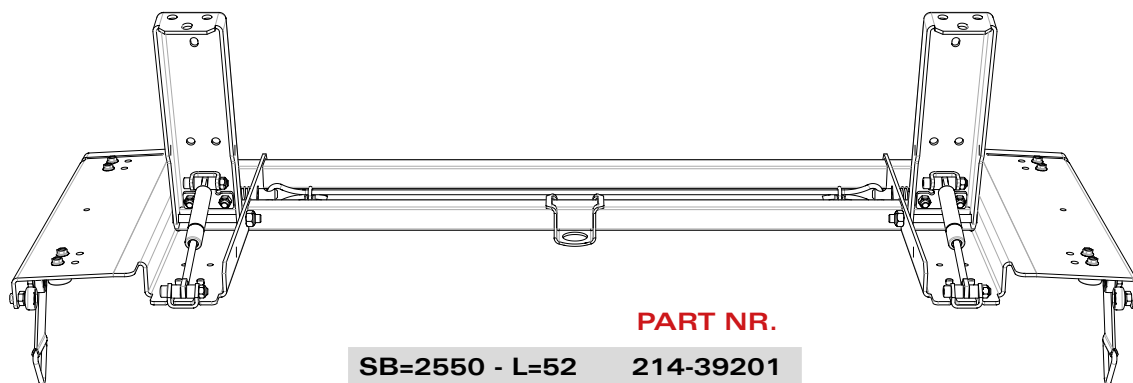

PART NR.
SB=2550 - L=52 214-39201

3b Collapsible backside for fixed roof with tarpaulin cover

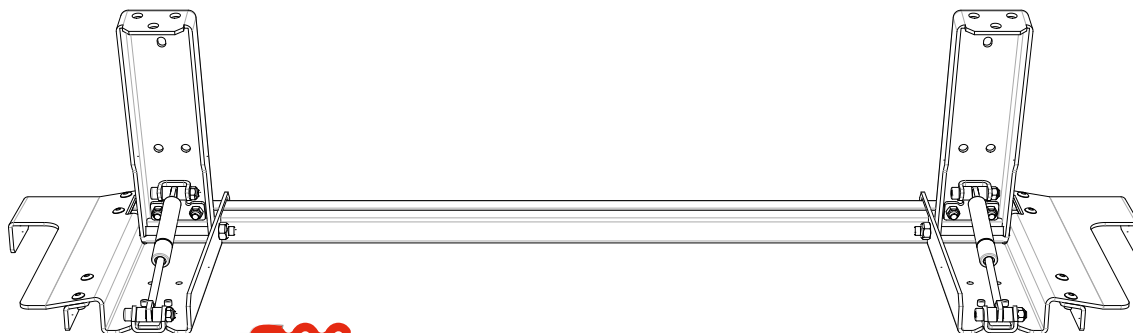

PART NR.
SB=2550 - L=100 324-39201

Front header

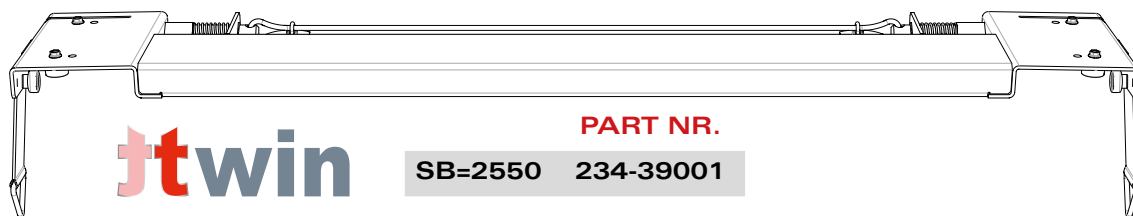

PART NR.
SB=2550 234-39001

6a Set accessories

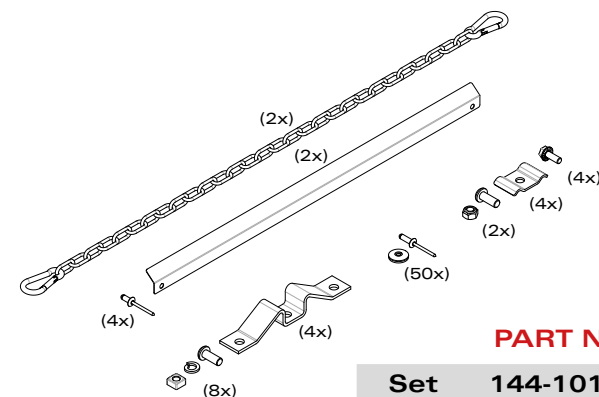

PART NR.
Set 144-10148

6b Set accessories Twin

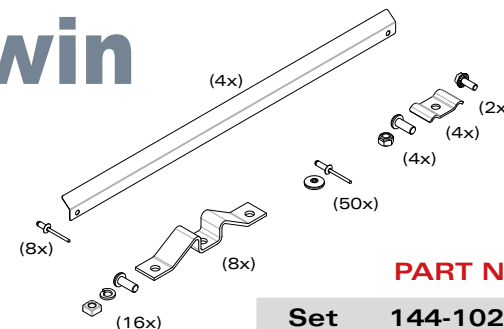

PART NR.
Set 144-10248

* Solo Penta Twin sliding roof: this set replaces the basic set accessories (144-10001)!

6c Set lock collapsible backside

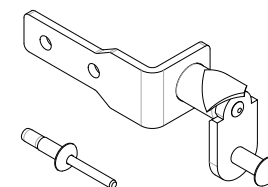

PART NR.
Set 144-10086

6d Set accessories external unlocking



PART NR.
Set 144-10174

4a Back beam

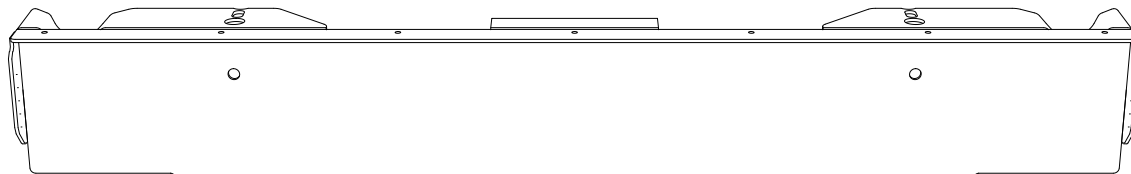

	PART NR.
SB=2550 - 145Z	193-39001
Mounting set	144-10022

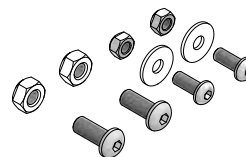

4b Back beam

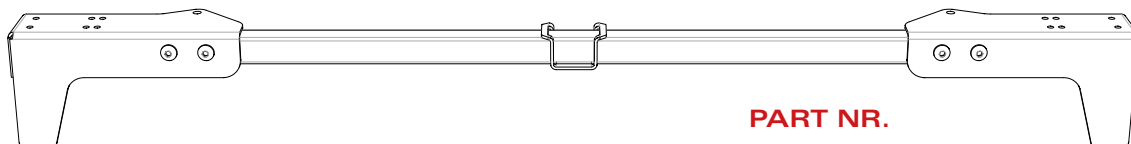

	PART NR.
Set back beam tube 30x30mm	144-10037
Tube 30x30x2mm	112-39001

Rain strip for back beam (4a)

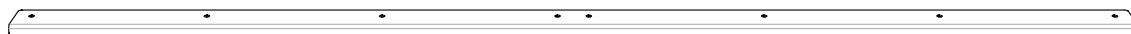

	PART NR.
SB=2550	192-01601

Rain strip for front header

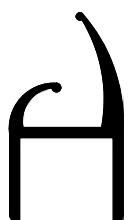

ttwin

	PART NR.
Rain strip SB=2550	192-01606
PVC pelmet L = 2,6m (black)	242-20001
Mounting strip 30x5mm L = 2,6m	292-07001

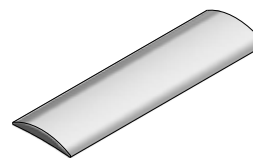

7 Folding plate

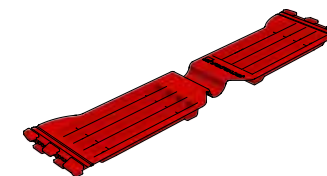

	PART NR.
Type 400	242-01004
Type 500	242-01005
Type 600	242-01006
Type 700	242-01007
Type 570	242-01057
Type 650	242-01065

5 PVC pelmet (black)



	PART NR.
L = 9m	242-02109
L = 14m	242-02114

9 Pull bars & webbing

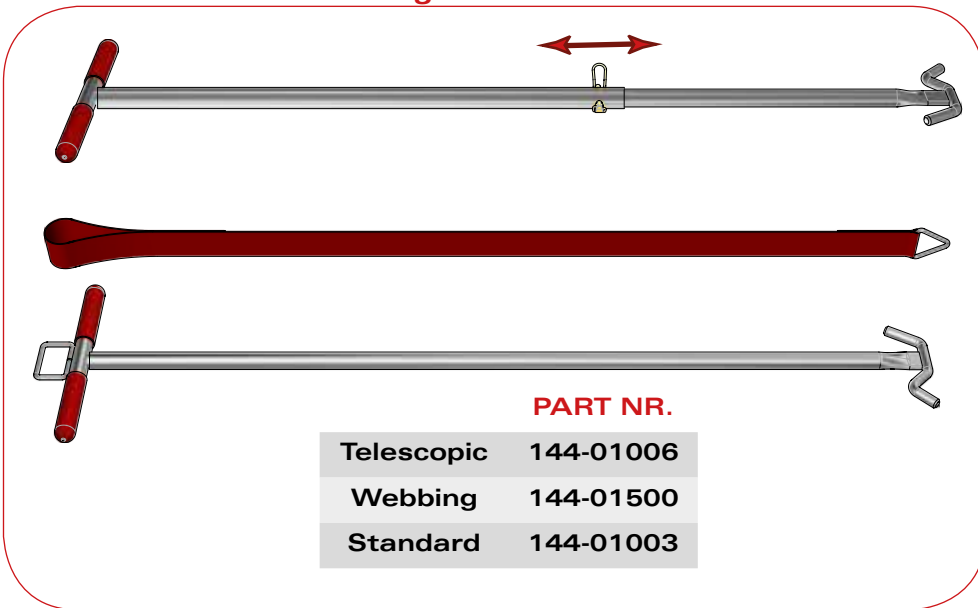

8 Carapax plate



PART NR.
291-03004

* only needed for roof with Carapax cover

Roller

* Please see chapter Penta Slider Systems for options!

For roof sticks

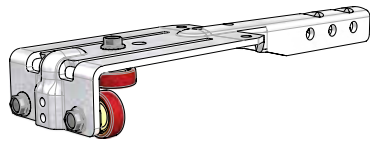

Assembled bracket

PART NR.

174-39001



Roller bearing plastic

PART NR.

132-01001



Bolt tensilock M6x16mm

PART NR.

091-23001

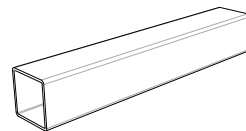

Tube 30x30x1,5mm

PART NR.

L = 2185mm 112-01003

For collapsible backside

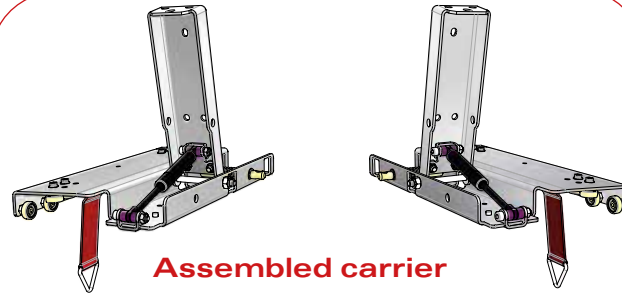

Assembled carrier

PART NR.

Left 204-39201

Right 204-39202

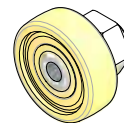

Roller bearing steel

PART NR.

132-03001



Bolt tensilock M6x16mm

PART NR.

091-23001

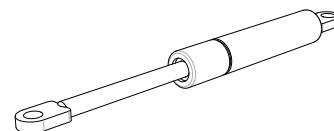

Gas spring 700N

PART NR.

302-01001

For accessories set

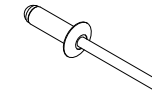

Rivet & washer

PART NR.

50 pieces 144-10003



Rope clamp

PART NR.

292-01001

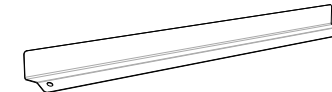

Protection plate

PART NR.

142-06006

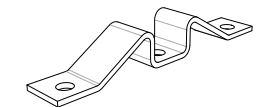

Locking nose

PART NR.

142-05002

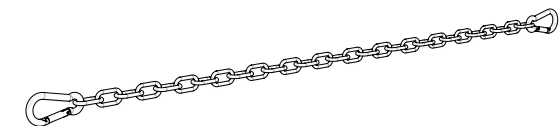

Chain with 2 hooks

PART NR.

142-07001



Versus-Omega
Nijverheidslaan 1527a
B-3660 Oudsbergen
Belgium

t. +32 89 320 190
f. +32 89 320 199
e. info@versus-omega.com
w. www.versus-omega.com

